

CONFIDENTIAL

VERTRAULICH

THIS DRAWING IS THE EXCLUSIVE PROPERTY OF MARQUARDT. WITHOUT THEIR CONSENT IT MAY NOT BE REPRODUCED OR GIVEN TO THIRD PARTIES.

Alle Rechte bei Marquardt, auch fuer den Fall von Schutzrechtsanmeldungen. Jede Verfuugungsbezugnis, wie Kopier- und Weitergaberecht, bei uns.

1	2	3	4
recommended cut-out for snap-in fixing (edge opposite to snap-in direction)	wall thickness	length of cut-out	width of cut-out
	0.8 to 5.0	27.2 ±0.1	12.2+0.2

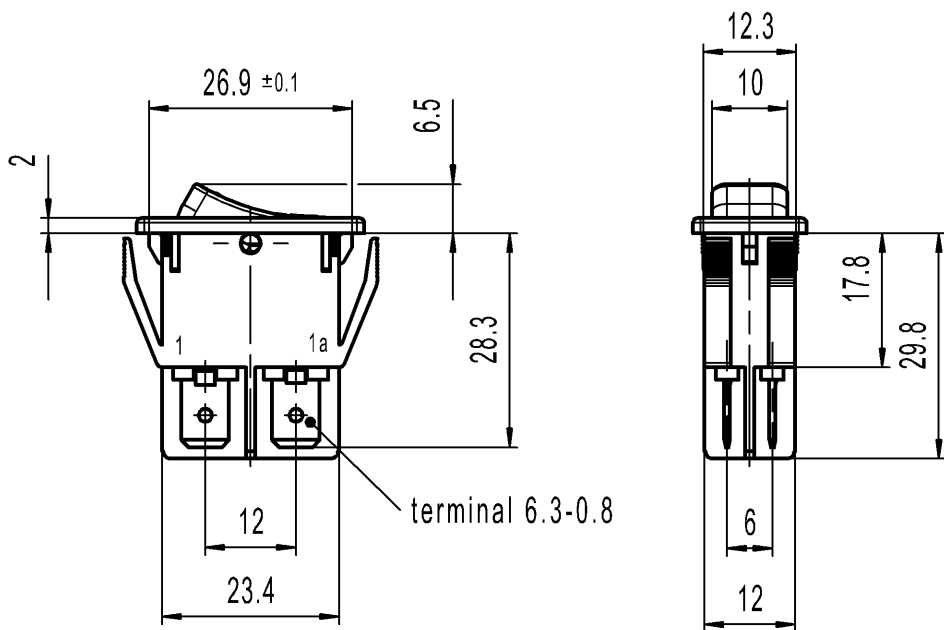

Marking



 155..
 16 (4) / 250 ~ T100/55 T100
 10 (4) / 250 ~ 5E4
 5/100A 250V ~

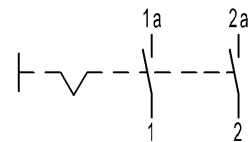

16A 125-250V AC
 1 HP 125V AC
 2 HP 250V AC
 R38 



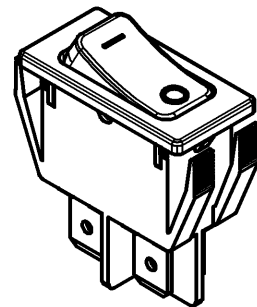

DPST



Code of manufacture:
place/year/week

Suitable for appliances of class II

-	-	-	1552.3104-XX																																			
Figure	Type	Customer No.	Art.No.-PI																																			
Shape and location	Angle ± 2°	Sheet 01																																				
	Edge tolerance	Ident. K	Document number 15523104																																			
	<table border="1"> <thead> <tr> <th colspan="2">Length</th> <th colspan="2">Radii</th> </tr> <tr> <th>>0-6</th> <th>± 0.2</th> <th>>0-6</th> <th>± 0.2</th> </tr> </thead> <tbody> <tr> <td>>6-15</td> <td>± 0.4</td> <td>>6-15</td> <td>±</td> </tr> <tr> <td>>15-30</td> <td>± 0.4</td> <td>>15-30</td> <td>±</td> </tr> <tr> <td>>30-70</td> <td>± 0.6</td> <td>>30-200</td> <td>±</td> </tr> <tr> <td>>70-120</td> <td>±</td> <td></td> <td>±</td> </tr> <tr> <td>>120-200</td> <td>±</td> <td></td> <td>±</td> </tr> <tr> <td></td> <td>±</td> <td></td> <td>±</td> </tr> <tr> <td></td> <td>±</td> <td></td> <td>±</td> </tr> </tbody> </table>	Length		Radii		>0-6	± 0.2	>0-6	± 0.2	>6-15	± 0.4	>6-15	±	>15-30	± 0.4	>15-30	±	>30-70	± 0.6	>30-200	±	>70-120	±		±	>120-200	±		±		±		±		±		±	Index e
		Length		Radii																																		
>0-6	± 0.2	>0-6	± 0.2																																			
>6-15	± 0.4	>6-15	±																																			
>15-30	± 0.4	>15-30	±																																			
>30-70	± 0.6	>30-200	±																																			
>70-120	±		±																																			
>120-200	±		±																																			
	±		±																																			
	±		±																																			
e	134536	2020-11-02	MATHPATIR																																			
d	69572	2010-09-30	HHE																																			
b	23635	1995-11-10	RS																																			
a	21323	1992-04-22	MUT																																			
Index	MEC-No.	Date (YYYY-MM-DD)	Edited by																																			
Format DIN A4		Projection 	Scale 1:1																																			
All dimensions are in millimetres																																						
System NX V11.0		Replacement of Zg.gl.Nr.v.09.01.1990																																				
		Appliance Switch																																				
				MARQUARDT																																		